



4x16 mm

A  
6x



4 mm

B  
26x



w4mm

C  
26x

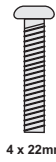

4 x 22mm

D  
8x



3x16 mm

E  
4x



4 x 40mm

F  
4x



Ø6mm

G  
20x



6x 30mm

H  
20x

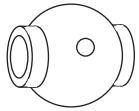

I  
4x



J  
16x



K  
32x

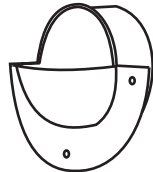

L  
2x



M  
11x



N  
11x

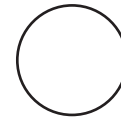

O  
3x

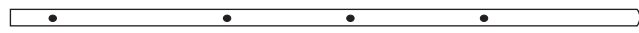
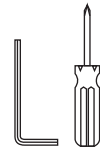

P 4x



T 8x



U 8x

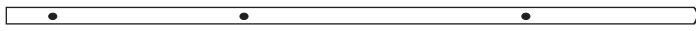

Q 2x

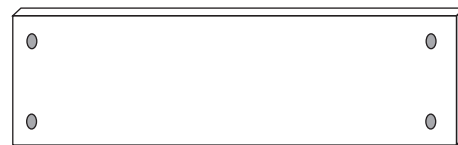

DD 2x



R 2x



S 2x



EE 2x

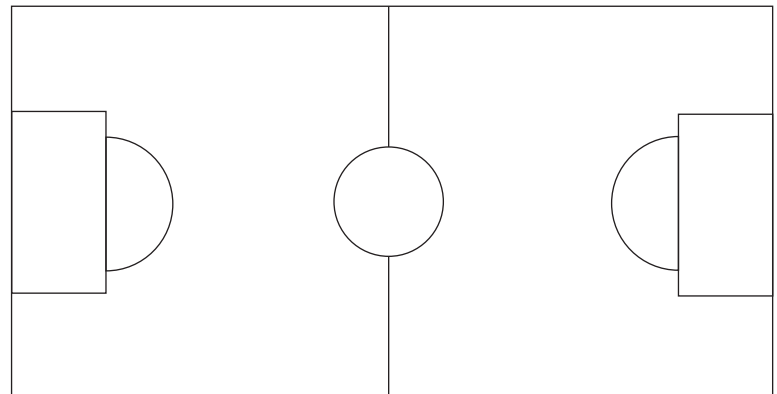

CC 1x

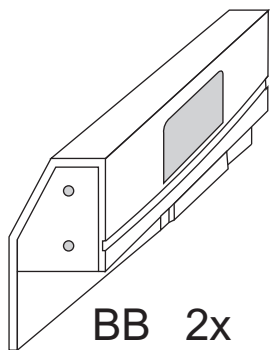

BB 2x

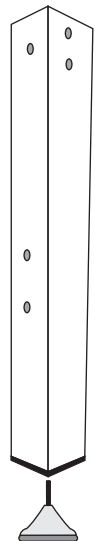

GA 2x

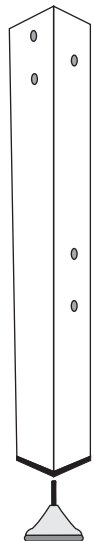

GB 2x

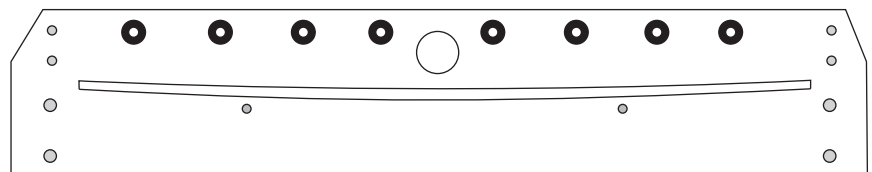

AA 2x

1

# 2

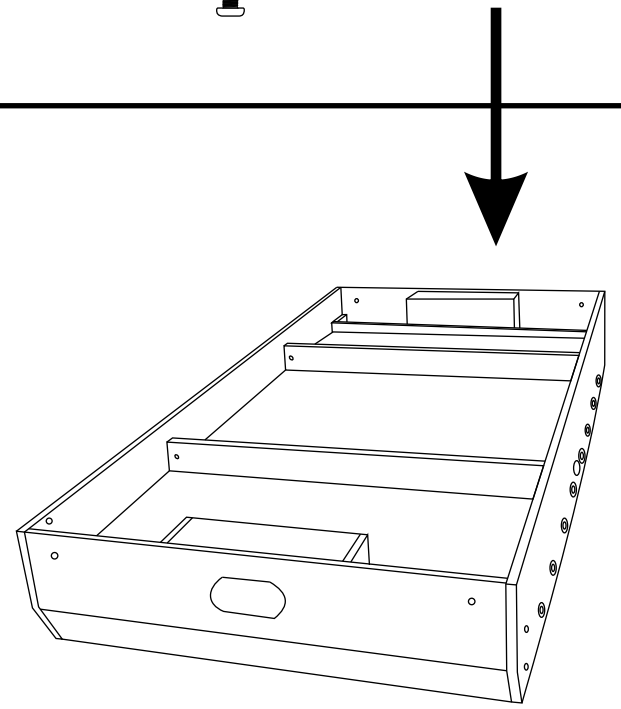
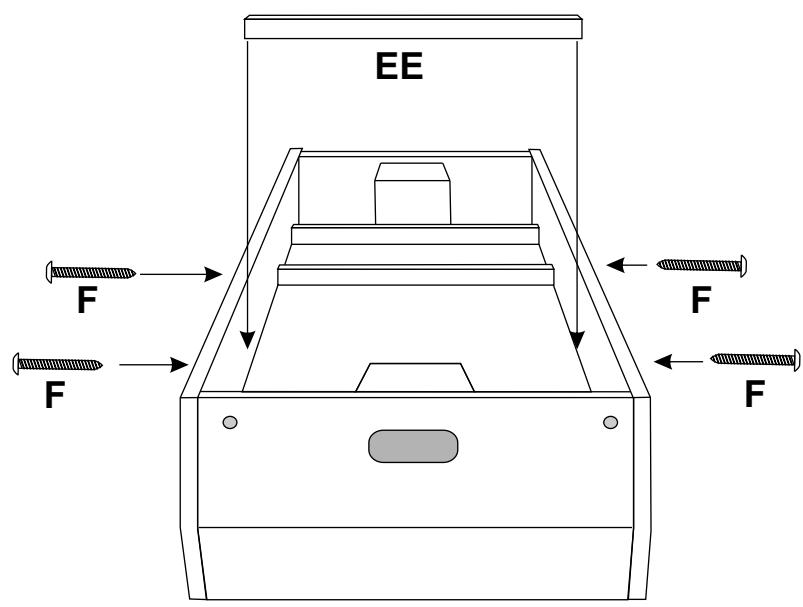
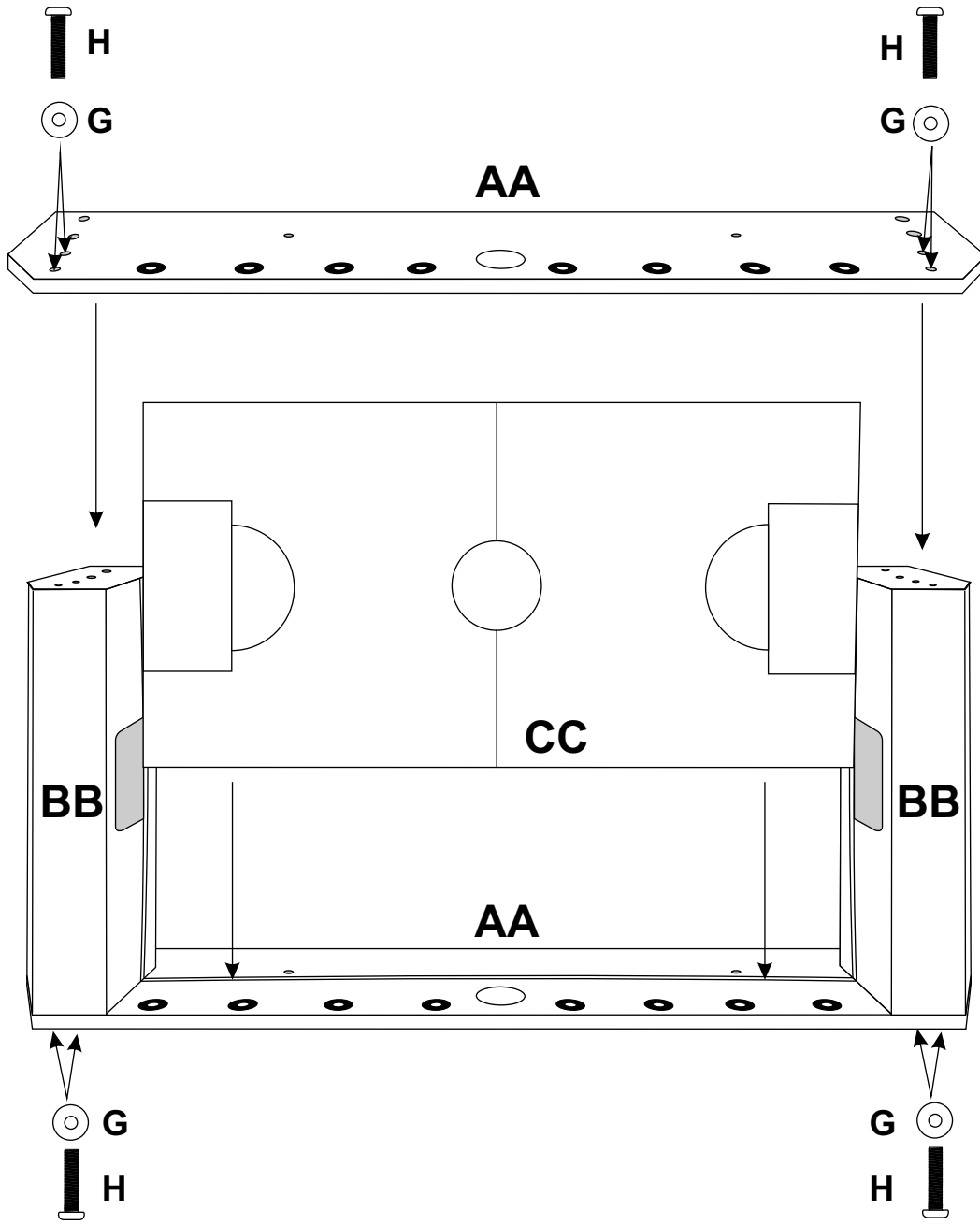

# 3

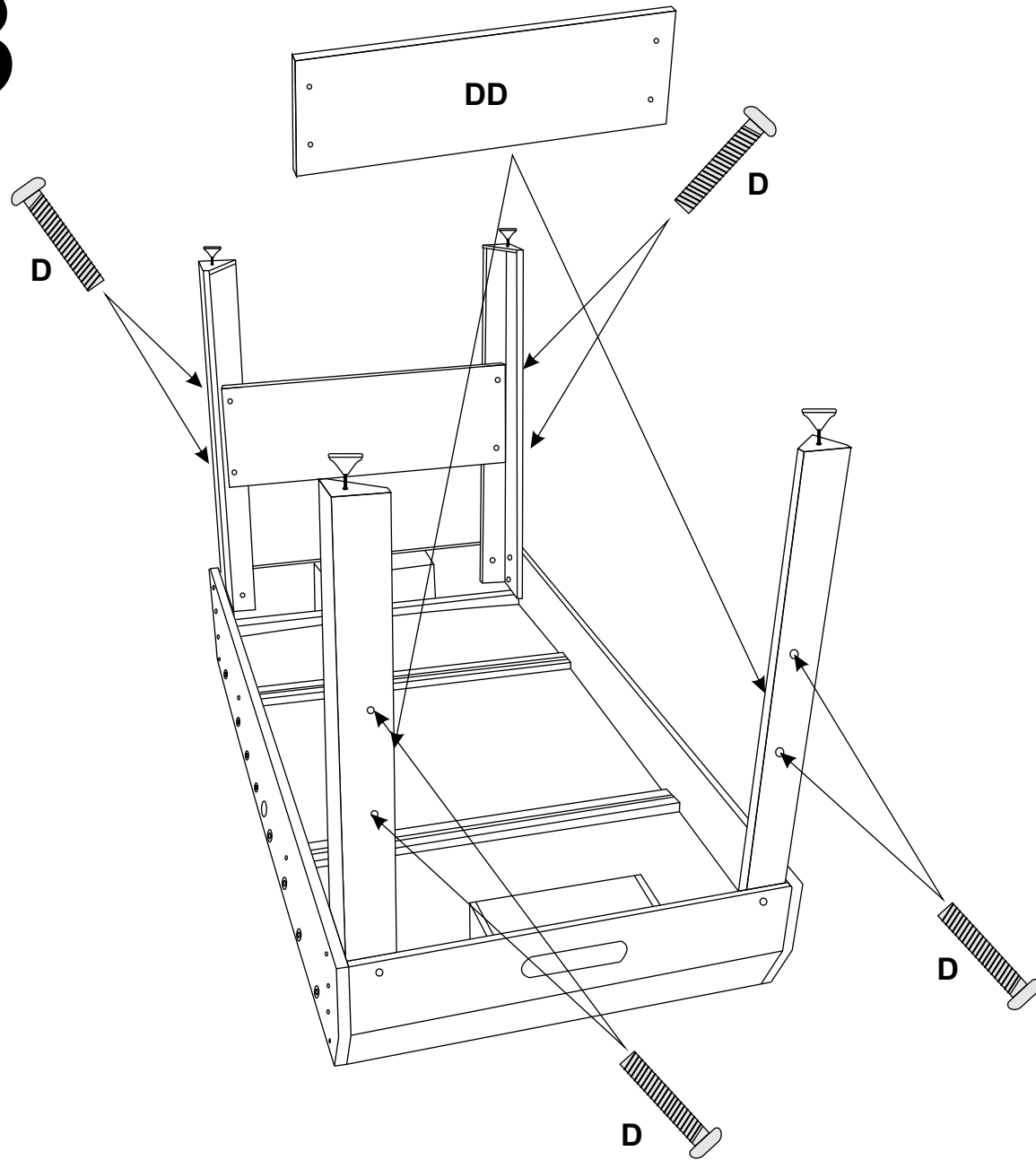
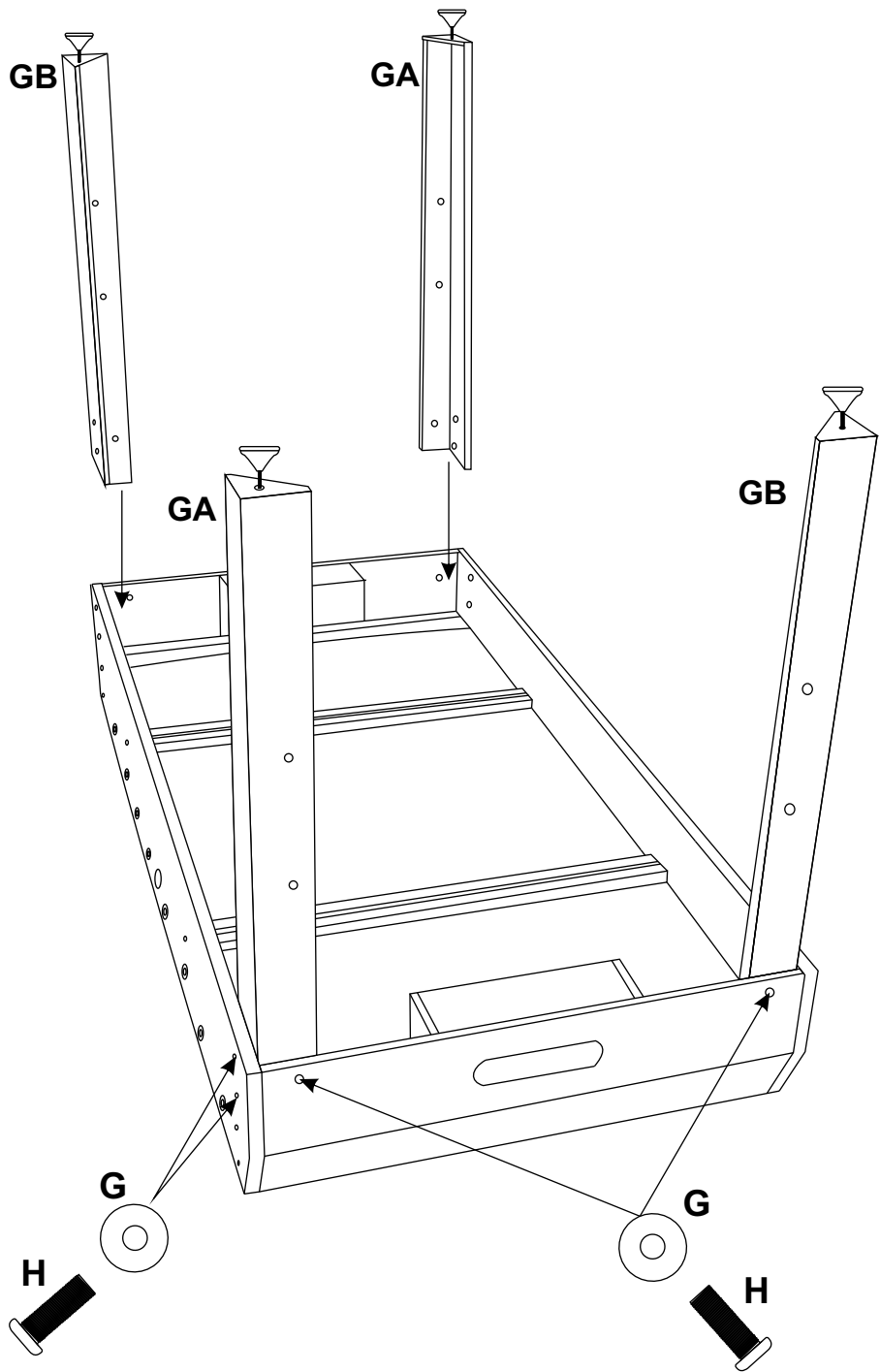

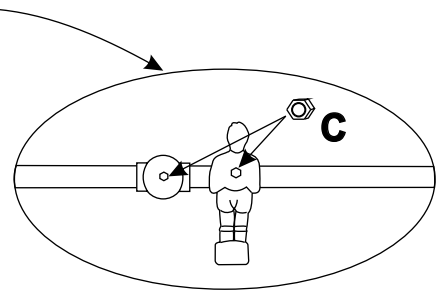
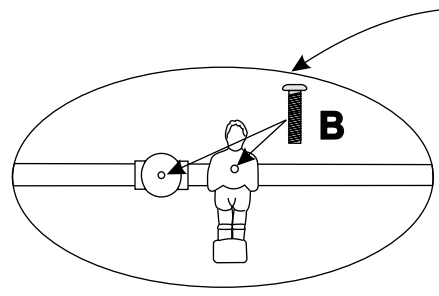
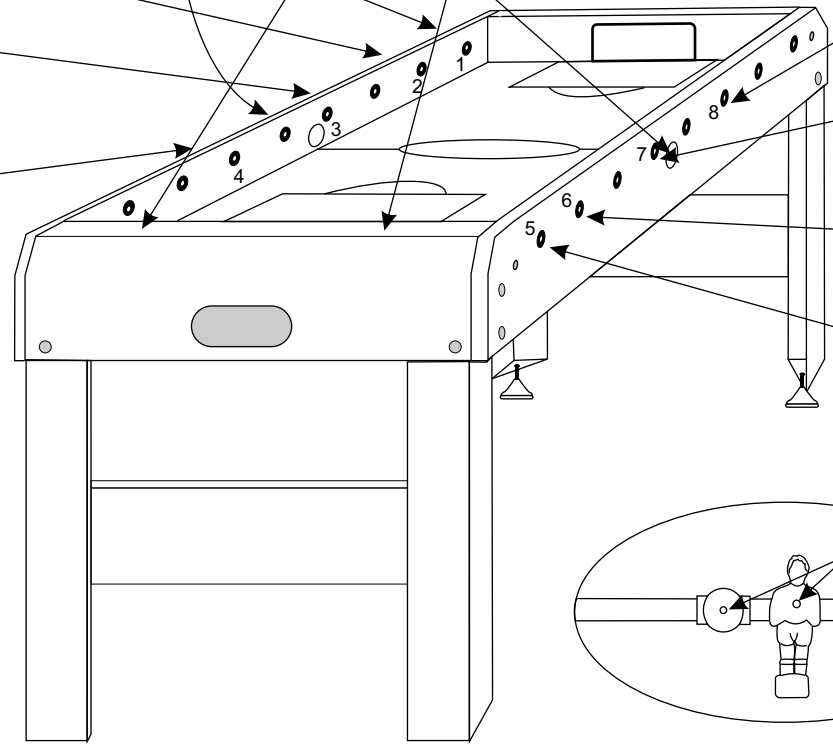
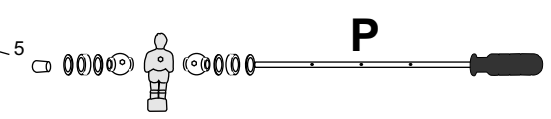
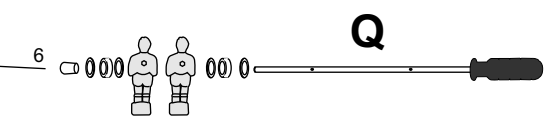
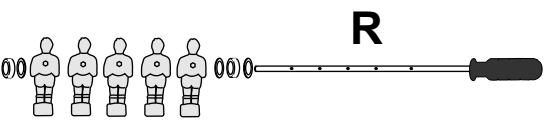
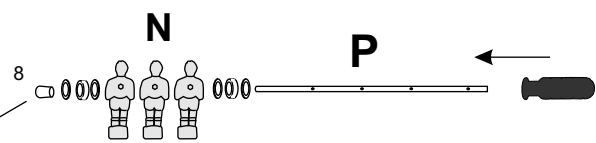
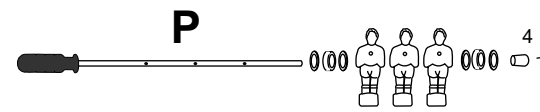
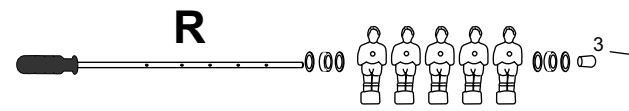
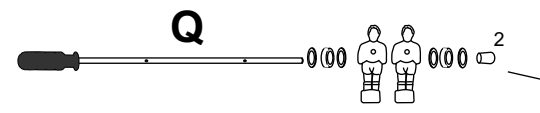
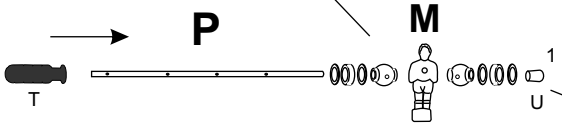
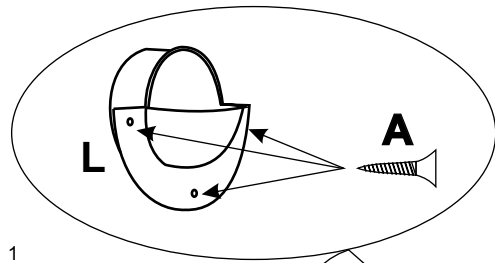
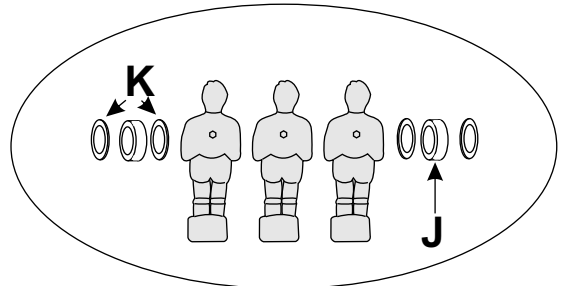
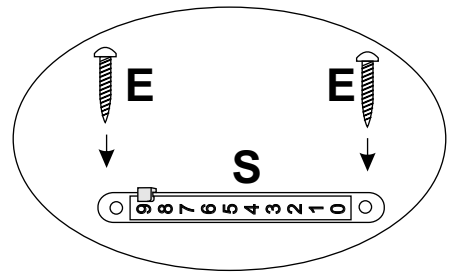
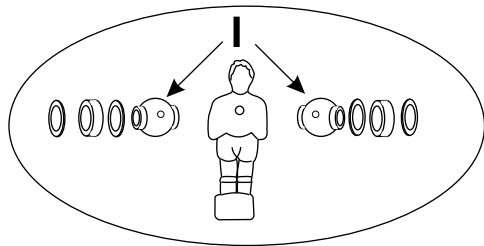

**4**