

(GR) ΤΡΙΚΥΚΛΟ ΟΔΗΓΙΕΣ ΧΡΗΣΗΣ

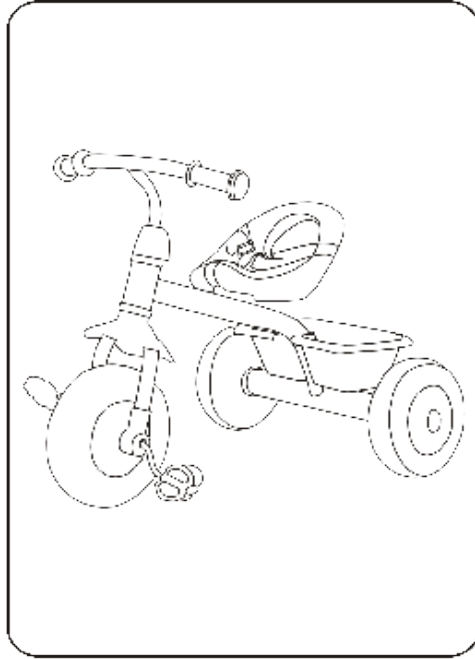

**Διαβάστε τις οδηγίες χρήσης πριν τη χρήση του προϊόντος.
Ενημερωθείτε για τη σωστή συναρμολόγηση και λειτουργία του
και αποθηκεύστε τις σε ασφαλές μέρος για μελλοντική αναφορά.**

Παρατηρήσεις:

- Προτεινόμενη ηλικία: 1- 5 ετών
- Μέγιστο βάρος: 25 κιλά
- Το προϊόν πρέπει να συναρμολογηθεί από κάποιον ενήλικα και μακριά από τα παιδιά για την αποφυγή κατάποσης των μικρών εξαρτημάτων.
- Το προϊόν αυτό δεν πρέπει να χρησιμοποιείται σε δρόμους και αυτοκινητόδρομους.
- Το προϊόν δεν είναι σχεδιασμένο για ακροβατικά.
- Ο κατασκευαστής δεν φέρει καμία ευθύνη για τυχόν τραυματισμούς και ζημιές, όπου μπορεί να προκληθούν κατά τη λειτουργία του προϊόντος.
- ΠΡΟΣΟΧΗ! Θα πρέπει να φοράτε τον προστατευτικό εξοπλισμό.
- Το προϊόν πρέπει να χρησιμοποιείται με τη βοήθεια και επίβλεψη ενήλικα για την αποφυγή σοβαρών τραυματισμών.
- Μην το αποθηκεύετε στον ήλιο ή σε υγρό περιβάλλον, όταν δεν το χρησιμοποιείτε.
- Κρατήστε το μακριά από τη φωτιά και μην το χρησιμοποιείτε στην άμμο ή το νερό.
- Κάντε καλή συντήρηση του προϊόντος για την αποφυγή ατυχημάτων.

Όνομα εξαρτήματος

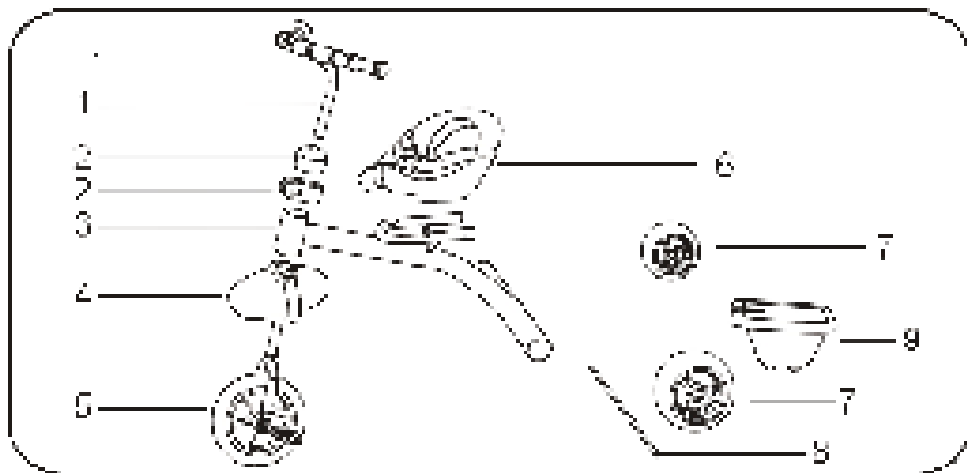

Αύξων αριθμός	Όνομα εξαρτήματος	Αύξων αριθμός	Όνομα εξαρτήματος	Αύξων αριθμός	Όνομα εξαρτήματος
1	Τιμόνι	4	Προφυλακτήρας	7	Πίσω τροχός
2	Σφιγκτήρας καλαθιού και τιμονιού	5	Μπροστινός τροχός	8	Πίσω άξονας
3	Σκελετός	6	Σέλα	9	Καλάθι

Σωλήνας μπροστινού πιρουνιού

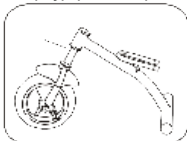

1. Συναρμολόγηση μπροστινού τροχού

Προσαρμόστε τον προφυλακτήρα στον μπροστινό τροχό και στη συνέχεια ενώστε το σωλήνα του μπροστινού πιρουνιού με το σκελετό, όπως φαίνεται στην εικόνα.

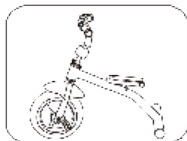

2. Τοποθέτηση τιμονιού

Ακολουθήστε την εικόνα και εισαγάγετε το σφιγκτήρα του τιμονιού στο χαμηλότερο άκρο του τιμονιού. Στη συνέχεια τοποθετήστε το τιμόνι στο σωλήνα του μπροστινού πιρουνιού και βιδώστε τους σφιγκτήρες με κοχλία σύσφιξης.

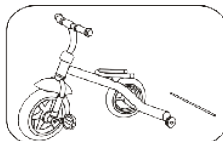

3. Τοποθέτηση πίσω άξονα

Περάστε τον πίσω άξονα μέσα από το σκελετό και ασφαλίστε τον με τις τάπες, όπως φαίνεται στην εικόνα.

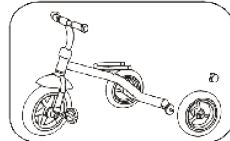

4. Τοποθέτηση πίσω τροχού

Προσαρμόστε καλά τους πίσω τροχούς στο σκελετό βιδώνοντας τις περόνες στο κέντρο των τροχών, όπως φαίνεται στην εικόνα.

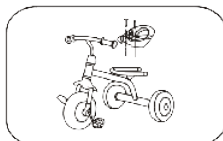

5. Τοποθέτηση σέλας

Τοποθετήστε και βιδώστε τη σέλα στη βάση του σκελετού, όπως φαίνεται στην εικόνα.

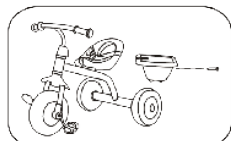

6. Τοποθέτηση καλαθιού

Τοποθετήστε και βιδώστε καλά το καλάθι στο πίσω μέρος του τρίκυκλου πάνω στο σκελετό, όπως φαίνεται στην εικόνα.

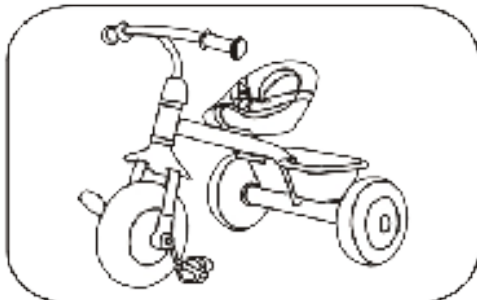

Τοποθετήστε το μωρό σας στη σέλα και προσαρμόστε το τιμόνι.

(BG) ТРИКОЛКА ИНСТРУКЦИИ ЗА УПОТРЕБА

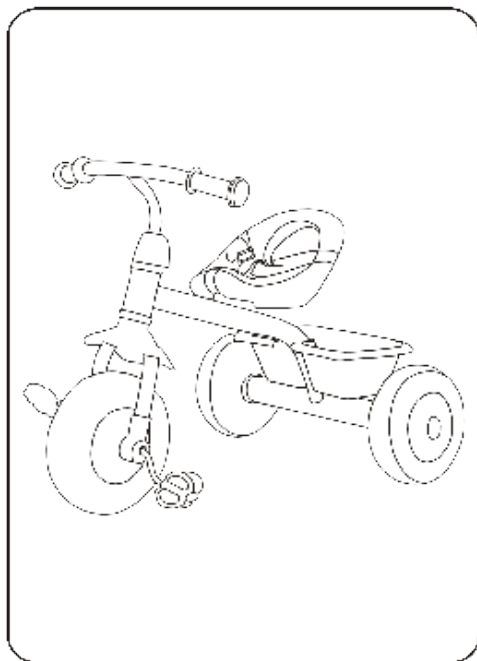

Информирайте се относно правилното сглобяване и функциониране на продукта. Прочетете внимателно инструкциите, преди употреба и ги запазете за бъдеща справка.

ЗАБЕЛЕЖКИ:

- Максимално тегло 25 кг.
- Сглобяването трябва да се извърши от възрастен, далеч от достъп на деца, за да се избегне опасност от поглъщане на малки частици.
- Да не се използва в близост до пътни платна.
- Този продукт не е предназначен за каскади.
- Производителят не носи никаква отговорност за евентуални инциденти, щети и наранявания, които биха могли да възникнат по време на употребата на продукта.
- **ВНИМАНИЕ!** Винаги носете предпазна екипировка
- Употребата на продукта изисква родителска помощ и наблюдение, за да се избегнат инциденти и сериозно нараняване.
- Съхранявайте на сухо и хладно място, далеч от пряка слънчева светлина.
- Пазете далеч от огън. Не използвайте върху песъчлива, мокра или хлъзгава повърхност.
- Проверявайте редовно изправността на продукта, за да избегнете инциденти и нараняване.

Списък на частите

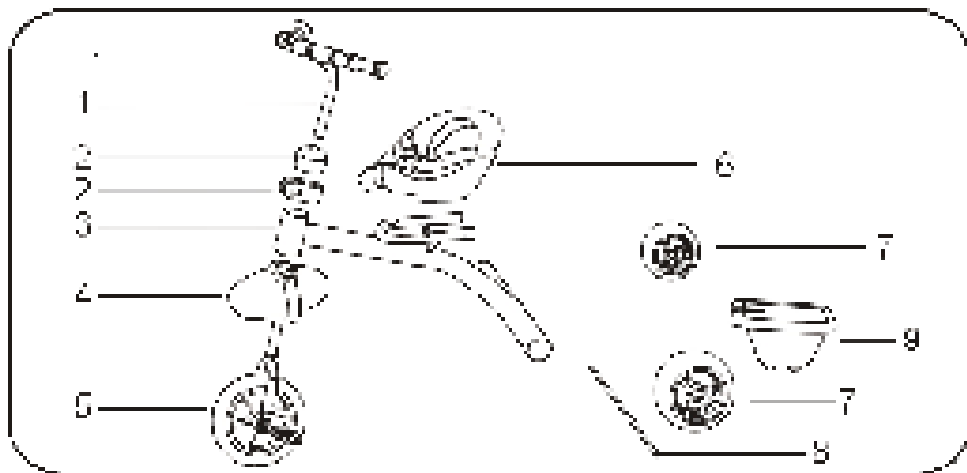

Номер	Наименование	Номер	Наименование	Номер	Наименование
1	Кормило	4	Калник	7	Задни колела
2	Държач на кормилото	5	Предно колело с вилка и педали	8	Ос на задните колела
3	Рамка	6	Седалка	9	Кош

Ос на предната вилка

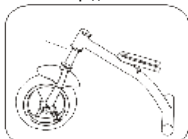

1. Поставяне на предното колело

Поставете калника върху оста на вилката и нанижете оста на вилката в предния отвор на рамката (както е показано на илюстрацията).



2. Поставяне на кормилото

Поставете държача на кормилната ос. Въведете кормилната ос в предния отвор на рамката и затегнете с държача (както е показано на илюстрацията).

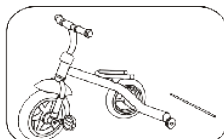

3. Поставяне на задната ос

Прекарайте оста на задните колела през задната ос на рамката. Прекарайте по една шайба от двата края на оста.

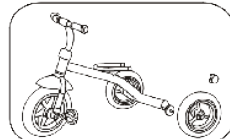

4. Поставяне на задните колела

Поставете прекарайте задните колела през двата края на задната ос. Фиксирайте всяко колело с пластмасова капачка (както е показано на изображението.)

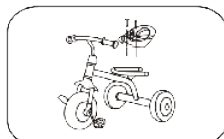

5. Монтиране на седалката

Поставете седалката върху металната и основа за седалка на рамката. Закрепете с винтовете и болтовете.

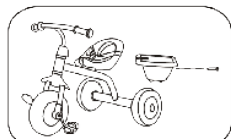

6. Монтиране на кош

Поставете кош върху рамката (както е показано на илюстрацията) и фиксирайте с винта.

(RO) TRICICLETĂ

INSTRUCȚIUNI DE UTILIZARE

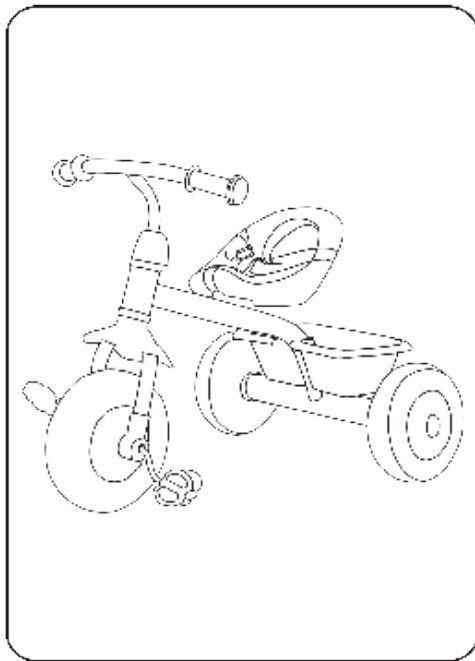

Vă rugăm să citiți cu atenție instrucțiunile de mai jos înainte de asamblare și păstrați-le pentru consultări ulterioare.

AVERTISMENTE:

- Vârsta recomandată: 1-5 ani
- Greutatea maximă suportată: 25 kg
- A se asambla de o persoană adultă. A nu se lăsa la îndemâna copiilor în timpul asamblării, conține piese mici ce pot fi înghițite
- A nu se utiliza pe suprafețe neuniforme, ude sau alunecoase, în pante, pentru a evita accidentele.
- Acest produs nu este destinat pentru cascadorii.
- Producătorul nu este responsabil pentru accidentări și daune de orice tip cauzate în timpul utilizării produsului.
- AVERTISMENT! A se utiliza cu echipament de protecție, a nu se utiliza în trafic.
- A se utiliza sub supravegherea și ajutorul unei persoane adulte pentru a preveni accidentele.
- Nu depozitați produsul în medii umede sau cu temperaturi ridicate.
- A se păstra departe de foc, a nu se utiliza în apă sau pe suprafețe cu nisip.

Descrierea pieselor

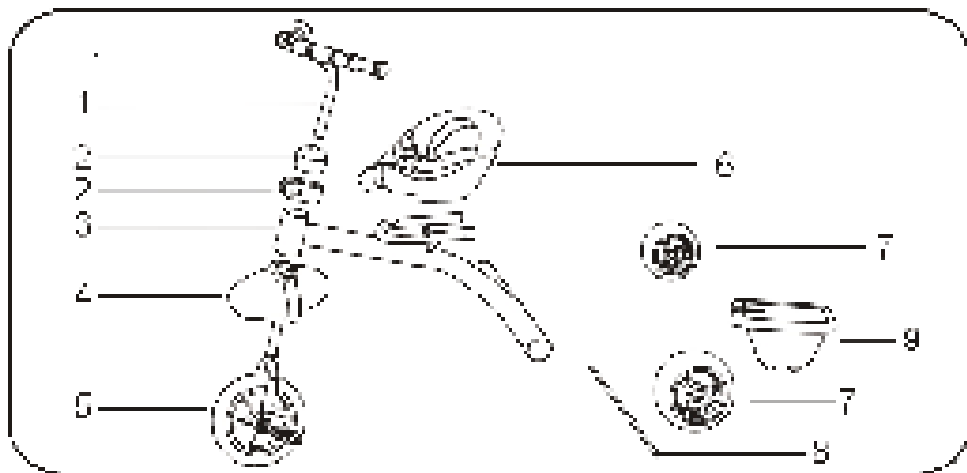

Nr.	Denumire	Nr.	Denumire	Nr.	Denumire
1	Ghidon	4	Aripă	7	Roată spate
2	Clemă ghidon și țevă	5	Roată frontală	8	Ax spate
3	Cadru	6	Șa	9	Cos bicicletă

Teavă Furcă frontală

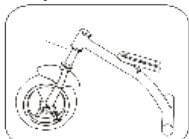

1.Asamblarea roții din față.
După cum este indicat în imagine introduceți roata din față în țevă.



2.Instalarea ghidonului.
Fixați ghidonul conform imaginii, folosiți clemă pentru a fixa ghidonul pentru furca.

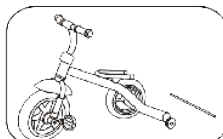

3.Instalarea axului din spate.
Introduceți axul prin cadru și apoi fixați garniturile după cum este indicat în imagine.

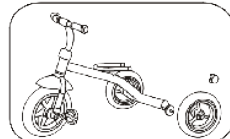

4.Instalarea roților din spate.
Montați roțile din spate din dreapta și din stânga, după cum este indicat în imagine. Asigurați-le cu garniturile.

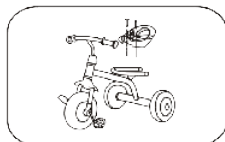

5.Instalare Șa.
Conform imaginii montați scaunul pe tricicletă, aliniați găurile pentru a fixa șuruburile.

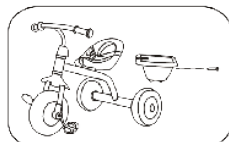

6.Instalarea coșului.
Montați coșul pe roțile din spate și fixați-l cu șuruburi după cum este indicat în imagine.

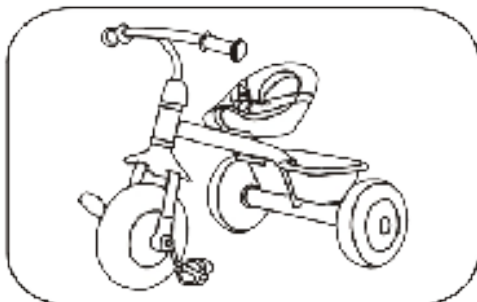

Produsul este gata de utilizare, puneți copilul în scaun și ajustați ghidonul.

(GB) TRICYCLE INSTRUCTIONS FOR USE

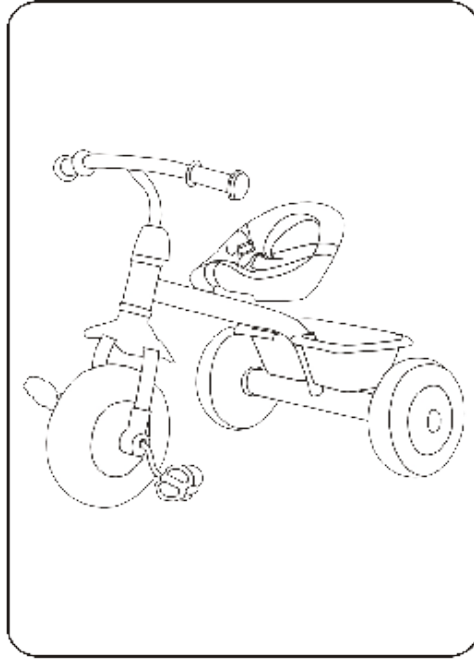

Please read and follow the instructions for use before using the product for correct assembly and operation. Keep it in a safe place for future reference.

Notes:

- Recommended age: 1 – 5 years
- Maximum weight: 25kg
- The product must be assembled by an adult and away from children to prevent them from swallowing small parts.
- Do not use the product on the road, or on motorways.
- The product is not designed for stunts.
- The manufacturer does not bear any responsibility for any injury and damage caused during the use of the product.
- **WARNING!** You should wear protective equipment during the use of the product.
- The product should be used under the help and supervision of an adult to prevent any serious injury.
- Do not store the product in the sun or wet place, when not in use
- Keep it away from fire and do not use in the sand or water.

Component name

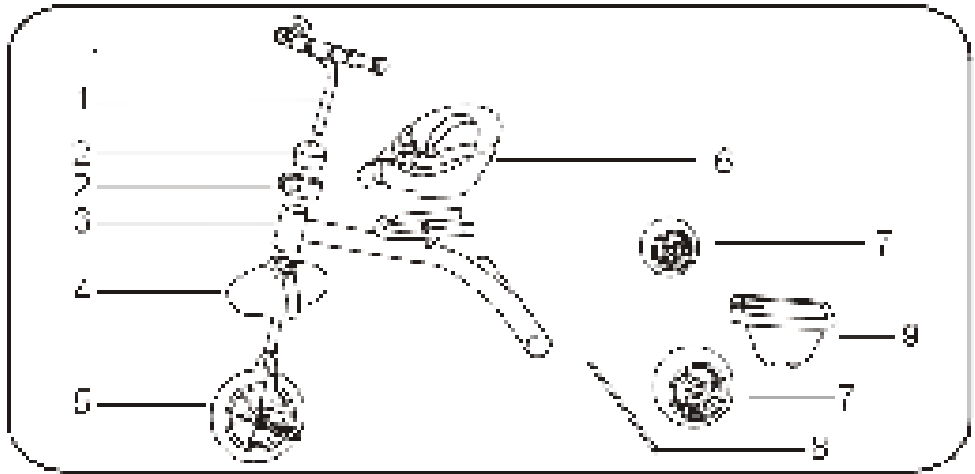

Serial number	Component name	Serial number	Component name	Serial number	Component name
1	Handlebar	4	Wing	7	Rear wheel
2	Basket and handlebar clamp	5	Front wheel	8	Rear axle
3	Frame	6	Saddle	9	Bicycle basket

Σωλήνας μπροστινού πιρουνού

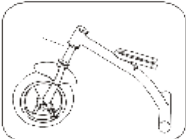

1. Front wheel installation
Adjust the wing on the front wheel and then connect the front fork tube to the frame, as shown in figure.

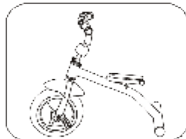

2. Handlebar installation
Insert the handlebar clamp into the lower end of the handlebar, then put the handlebar into the front fork tube and screw the clamping screws, as shown in figure.

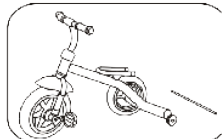

3. Rear axis installation
Pass the rear axis through the frame and secure with plugs, as shown in figure.

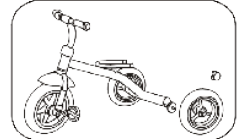

4. Rear wheel installation
Left and right rear wheels should be respectively sheathered in the rear axle screwing the cotter pins at the center of the rear wheels, as shown in figure.

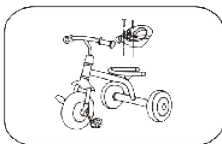

5. Saddle installation
Place and screw the saddle on the base of the frame, as shown in figure.

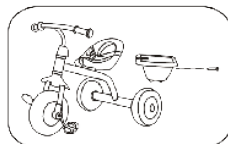

6. Basket installation
Place and screw tight the basket on the frame at the rear side of the tricycle, as shown in figure.

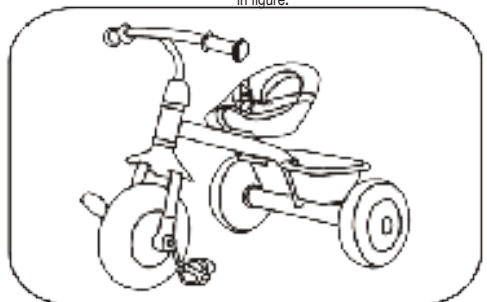

Put your baby on the saddle and adjust the handlebar.